

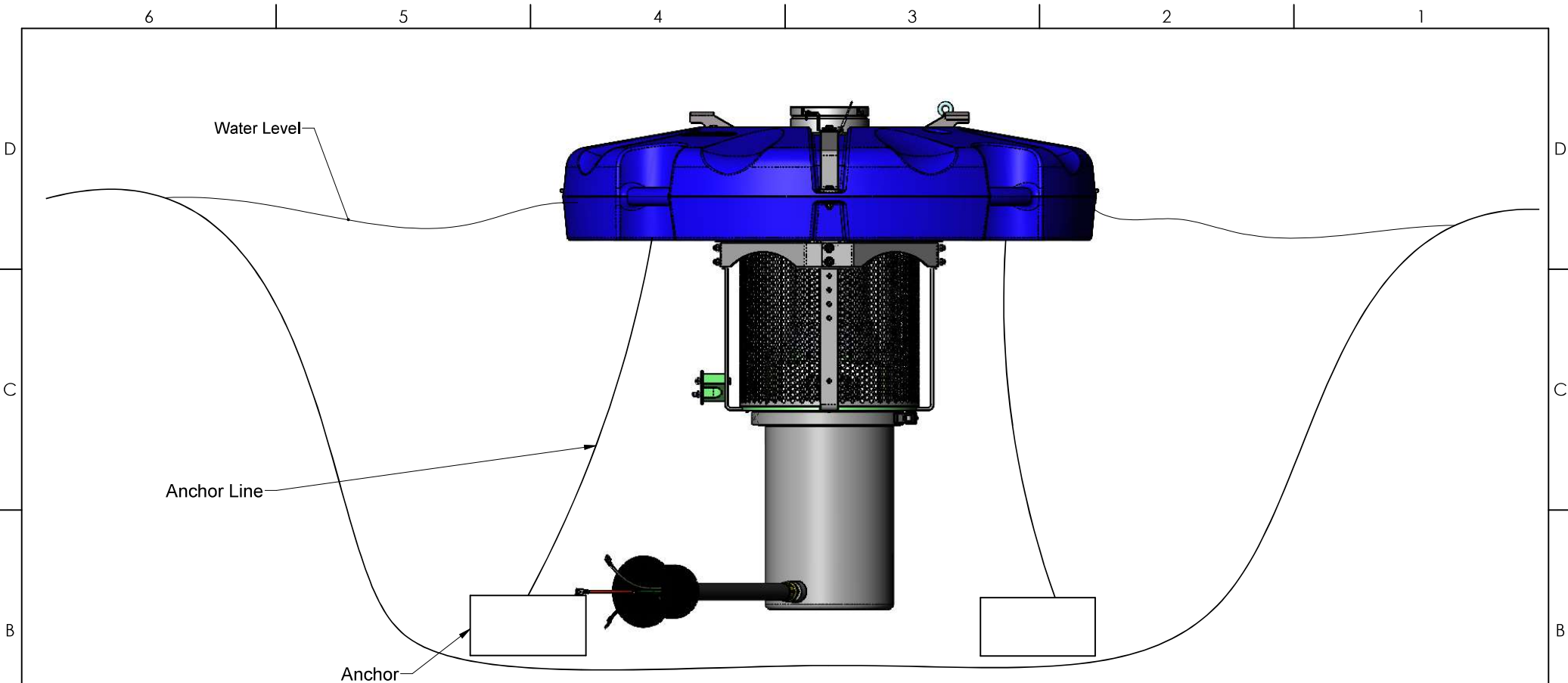

NOT TO SCALE

MATERIAL: SEE PART DRAWINGS		UNLESS OTHERWISE SPECIFIED: DIMENSIONS ARE IN INCHES (XXX) = MILLIMETERS		 16024 COUNTY RD. X, KIEL, WI. 53042 DESCRIPTION: Document, Reference, Owner's Manual Graphics
FINISH: NONE		TOLERANCES: INCH, [METRIC]		
DRAWN BY: OAH		.0" ± .030 .0 MM ± 0.8 .00" ± .015 .00 MM ± 0.4 .000" ± .005 .000 MM ± 0.1		
DATE: 2021-01-20		FRACTIONS ± 1/64 ANGLES: ± .5° DRAFT: ± 1°		
SHEET 3 OF 5	SCALE 1:12	SIZE B	DO NOT SCALE DRAWING PROPRIETARY AND CONFIDENTIAL	DWG. NO. 3003777
<small>THE INFORMATION CONTAINED IN THIS DRAWING IS THE SOLE PROPERTY OF AQUAMASTER. ANY REPRODUCTION IN PART OR AS A WHOLE WITHOUT THE WRITTEN PERMISSION OF AQUAMASTER IS PROHIBITED.</small>				REV A



NOT TO SCALE

MATERIAL: SEE PART DRAWINGS			UNLESS OTHERWISE SPECIFIED: DIMENSIONS ARE IN INCHES 1 XXX1 = MILLIMETERS			 16024 COUNTY RD. X, KIEL, WI. 53042
FINISH: NONE			TOLERANCES: INCH, [METRIC]			
DRAWN BY: OAH			.0" ±.030 .0 MM ±0.8 .00" ±.015 .00 MM ±0.4 .000" ±.005 .000 MM ±0.1			
DATE: 2021-01-20			FRACTIONS ±1/64 ANGLES: ±.5° DRAFT: ±1° 			
SHEET 4 OF 5	SCALE 1:12	SIZE B	DO NOT SCALE DRAWING PROPRIETARY AND CONFIDENTIAL			DESCRIPTION: Document, Reference, Owner's Manual Graphics
THE INFORMATION CONTAINED IN THIS DRAWING IS THE SOLE PROPERTY OF AQUAMASTER. ANY REPRODUCTION IN PART OR AS A WHOLE WITHOUT THE WRITTEN PERMISSION OF AQUAMASTER IS PROHIBITED.					DWG. NO. 3003777	REV A

6 5 4 3 2 1

Intermediate Weight
(Optional)

Pond

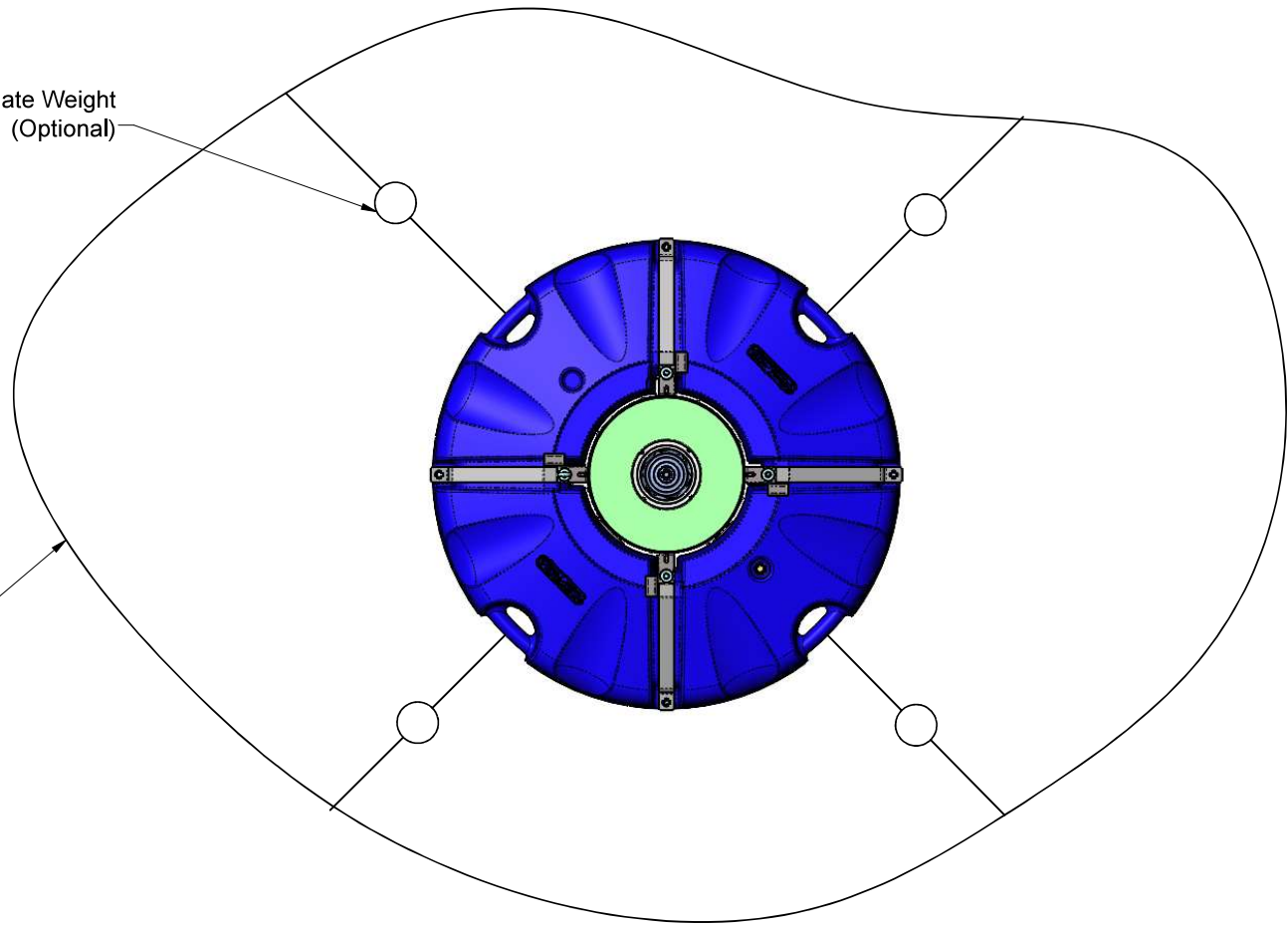

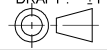
MATERIAL: SEE PART DRAWINGS			UNLESS OTHERWISE SPECIFIED: DIMENSIONS ARE IN INCHES 1 XXX1 = MM (MILLIMETERS)			 16024 COUNTY RD. X, KIEL, WI. 53042 DESCRIPTION: Document, Reference, Owner's Manual Graphics
FINISH: NONE			TOLERANCES: INCH, [METRIC]			
DRAWN BY: OAH			.0" ±.030 .0 MM ±0.8			
DATE: 2021-01-20			.00" ±.015 .00 MM ±0.4			
SHEET 5 OF 5			.000" ±.005 .000 MM ±0.1			
SCALE 1:12			FRACTIONS ±1/64			ANGLER: ±.5° DRAFT: ±1° 
SIDE B			DO NOT SCALE DRAWING			
PROPRIETARY AND CONFIDENTIAL			DWG. NO. 3003777			REV A

5 4 3 2 1